

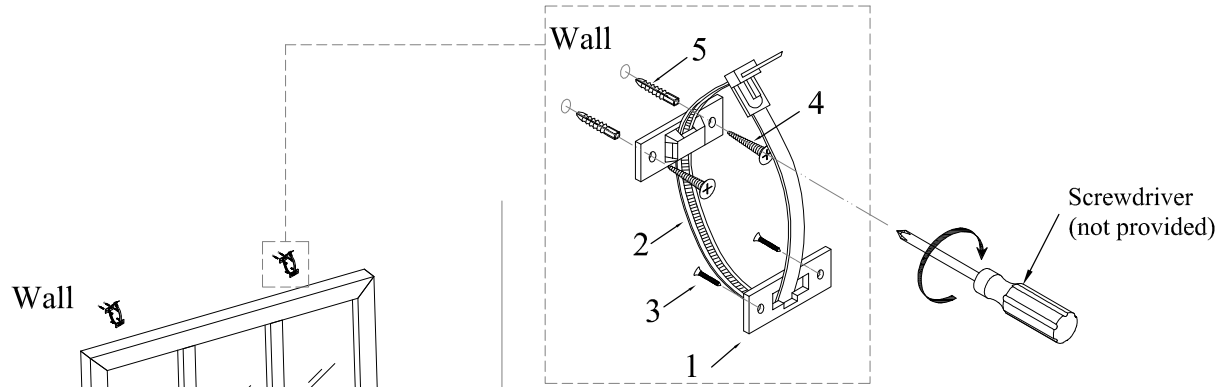





GRID MIRROR ASSEMBLY INSTRUCTIONS



HARDWARE LIST		
NO	DESCRIPTION	QTY
1	 Plastic Bracket	4PCS
2	 Restraint Strap	2PCS
3	 Short Screw	4PCS
4	 Long Screw	4PCS
5	 Anchor	4PCS

FINISHED DIAGRAM

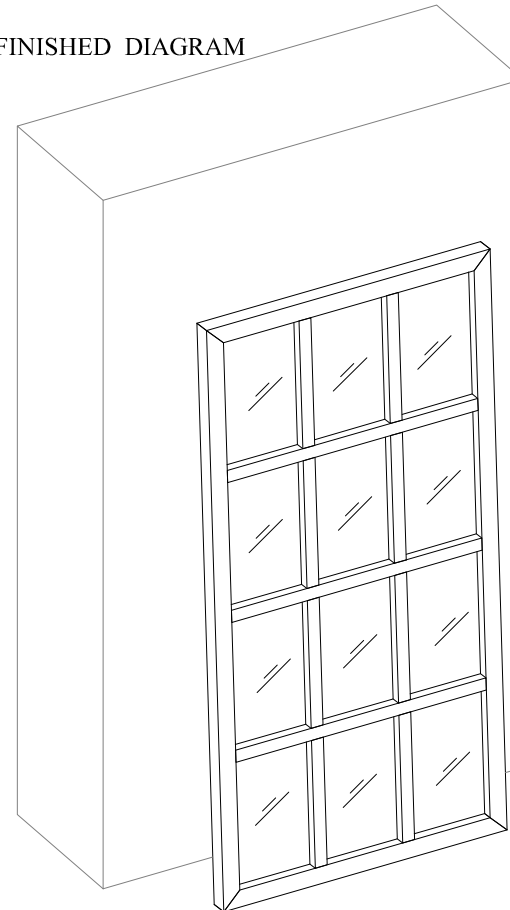

Note:
Because of the big size and weight of this item,
professional installation of the included Anti-Tip
kit is required.